

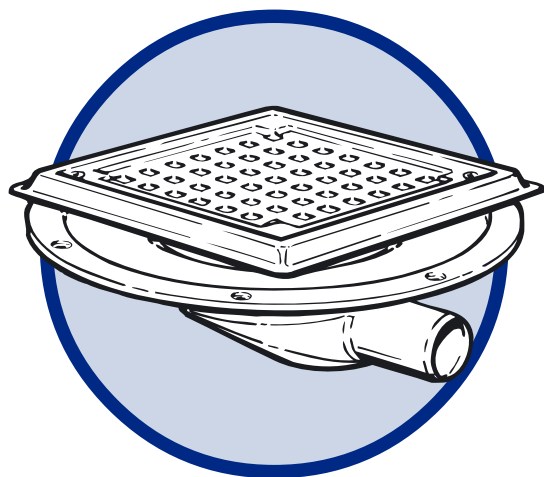

# BLÜCHER

**MONTERINGSVEJLEDNING  
INSTALLATION INSTRUCTIONS  
MONTAGEANLEITUNG  
INSTRUCTIONS DE MONTAGE**



No. 381.300.032



No. 181.300.032



No. 281.300.032

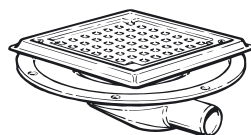

No. 381.300.032

Type No. 381

Afløb for betongulve med smøremembran  
Drains for concrete floors with watertight fluid membrane  
Bodenabläufe für Betonböden mit flüssigen Sperrschichten  
Siphon hauteur - sols beton

TILSLUTNING AF RØR / PIPE CONNECTION  
ROHRE ANSCHLIESSEN / RACCORDMENT

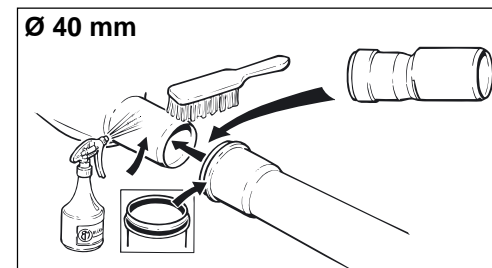
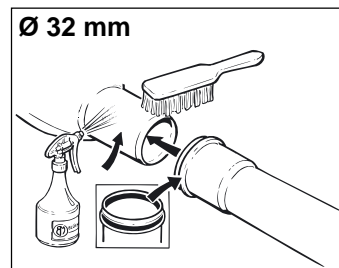

MONTERING I BETONGULV / INSTALLATION IN CONCRETE FLOORS  
MONTAGE IN BETONBÖDEN / POSE SUR PLANCHER BETON

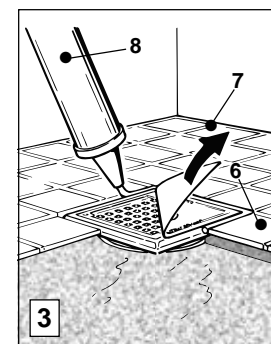
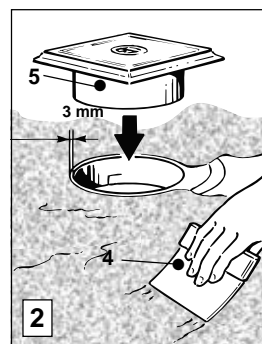
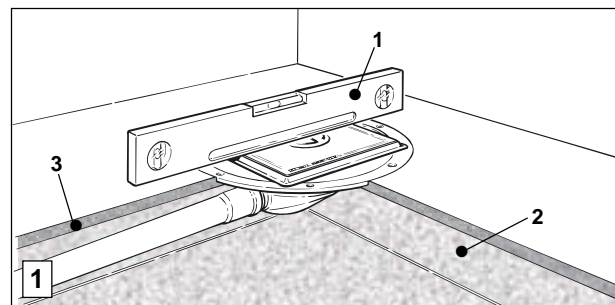

BM Marketing - 10.000.02.01 - Copyright by BLÜCHER - Varenr. 761181



# BLÜCHER

Pugdølvej 1 · DK-7480 Vildbjerg  
Tel. +45 99 92 08 00 · Fax +45 97 13 33 50  
www.blucher.com · mail@blucher.dk

# Type No. 181

Afløb for betongulve  
Drains for concrete floors  
Bodenabläufe für Betonböden  
Siphon pour sol béton

TILSLUTNING AF RØR / PIPE CONNECTION  
ROHRE ANSCHLIESSEN / RACCORDEMENT

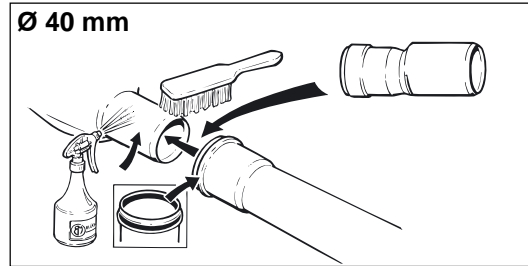
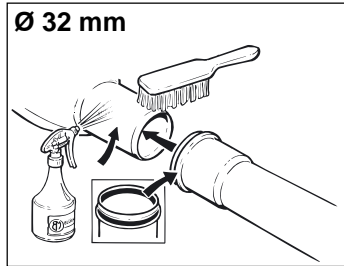

MONTERING I BETONGULV / INSTALLATION IN CONCRETE FLOORS  
MONTAGE IN BETONBÖDEN / POSE SUR PLANCHER BETON

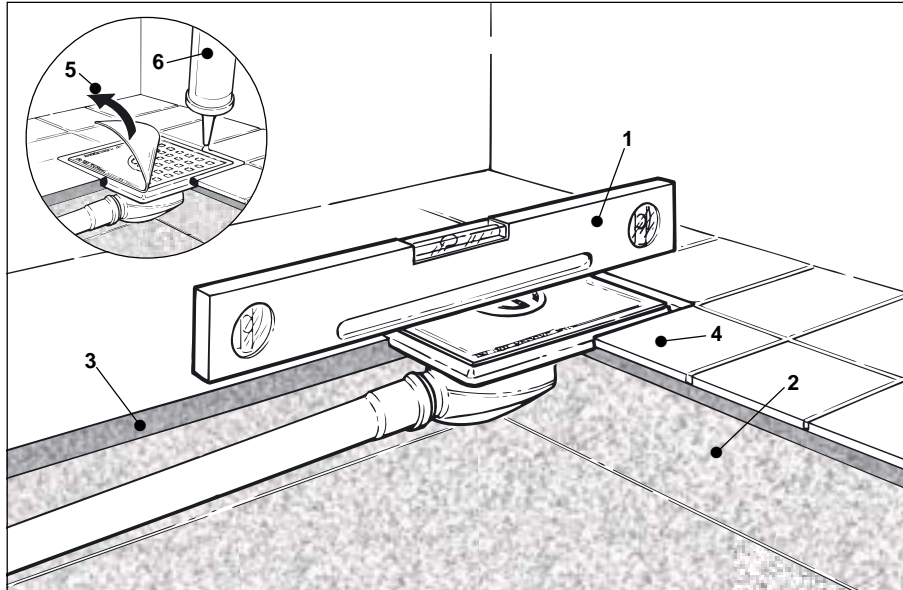

# Type No. 281

Afløb for vinylgulve  
Drains for vinyl floors  
Bodenablauf für Böden mit Vinylbelag  
Siphons pour sol vinyl

TILSLUTNING AF RØR / PIPE CONNECTION  
ROHRE ANSCHLIESSEN / RACCORDEMENT

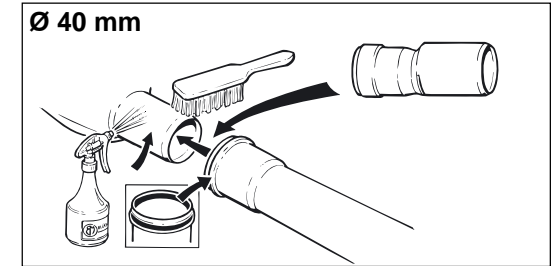

MONTERING I TRÆGULV  
INSTALLATION IN WOODEN FLOORS  
EINBAU IN HOLZBÖDEN  
IMPLANTATION SUR PLANCHER BOIS

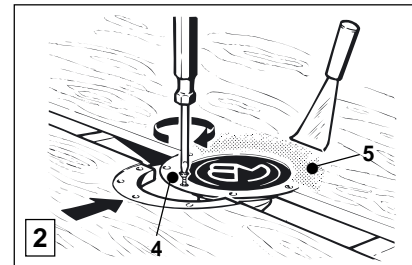
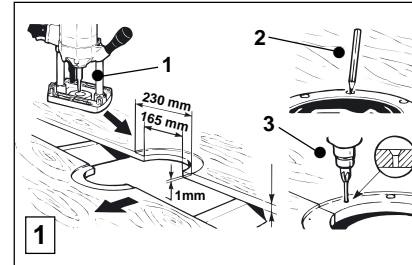

MONTERING I BETONGULV  
INSTALLATION IN CONCRETE FLOORS  
MONTAGE IN BETONBÖDEN  
POSE SUR PLANCHER BETON

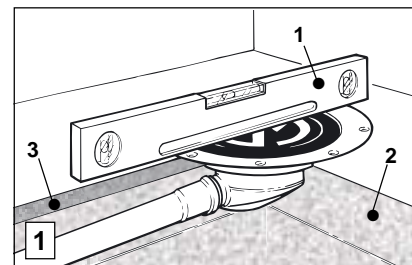

MONTERING AF VINYLBELÆGNING  
APPLICATION OF SHEET VINYL COVERING  
BEFESTIGUNG VON VINYLBELAG  
POSE DE REVETEMENT VINYL

